

REVISION			
REV.	DESCRIPTION	DATE	APPROVED
A	Changed P1 Pin Out / Changed Cable Spec From 30AWG To 28 AWG	03-12-07	DP

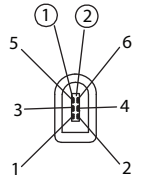

FRONT

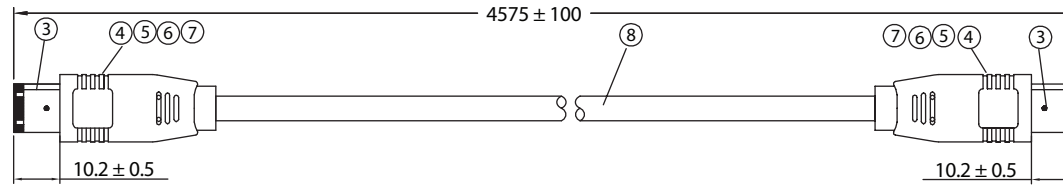

IEEE 1394 6P/M MOLDING TYPE
(TOOLING NO:G102-216)

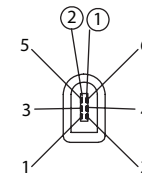

FRONT

P2

IEEE 1394 6P/M MOLDING TYPE
(TOOLING NO:G102-216)

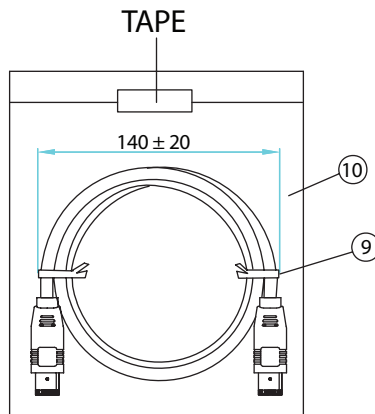

TAPE

PIN OUT

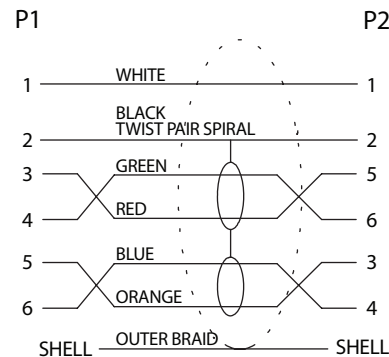

NOTES:

- CABLE: UL20276 IEEE1394 [(28AWGx1P+FOIL+SP)x2+22AWGx2C+MYLAR+FOIL+BD]x1
OUTER PVC JACKET: BLACK, OD: 6.2 ± 0.2mm
PRINTING: "E166307  AWM 20276 28AWG VW-1 IEEE Std 1394 Compliant"
- CONNECTORS: IEEE 1394 6P MALE TO IEEE 1394 6P MALE
- HOOD: MOLDED TYPE, COLOR: BLACK
- ELECTRICAL TEST:
 - <1>.100% OPEN SHORT & MISS WIRE TEST
 - <2>.INSULATION RESISTANCE: DC400V 10M ohm MIN.
 - <3>.CONDUCTOR RESISTANCE: 1 ohm MAX.
- PACKING: 1PC/POLYBAG

No.	PARTS NAME	SPECIFICATION STANDARD	QTY	REMARKS
①	6P/M - CONTACT	PHOSPHOR BRONZE / GOLD FLASH	12	
②	6P/M - INSULATOR	PBT / BLACK UL94V-0	2	
③	6P/M - SHELL 1	SHELL / NICKEL PLATED	2	
④	6P/M - SHELL 2	SHELL / NICKEL PLATED	2	
⑤	COPPER FOIL	5x10mm	2	
⑥	6P/M - INNER MOLD	PE / NATURAL	2	
⑦	6P/M - OUTER MOLD	45P PVC / COLOR: BLACK	2	
⑧	KL02003ABK01A	[(28AWGx1P+FOIL+SP)x2C+22AWGx2C+MYLAR+FOIL+BD]x1 COLOR: BLACK	1	
⑨	MINI TIE	PE / BLACK	2	
⑩	POLYBAG	PE / 0.08x180x200mm	1	

Dim range (mm)	Tolerance +/- (mm)	Qualtek Electronics Corp. WCT DIVISION											
		Part Number: 1821019-15											
0-1	0.15	Description: IEEE 1394 6P/M - IEEE 6P/M											
1-6	0.20	<table border="1"> <tr> <td colspan="2"></td> <td>REV. A</td> </tr> <tr> <td>Drawn / Date</td> <td>Checked / Date</td> <td>Approved / Date</td> </tr> <tr> <td>B.Grubb 01-25-07</td> <td>01-25-07</td> <td>JJH / 01-25-07</td> </tr> </table>					REV. A	Drawn / Date	Checked / Date	Approved / Date	B.Grubb 01-25-07	01-25-07	JJH / 01-25-07
					REV. A								
Drawn / Date	Checked / Date				Approved / Date								
B.Grubb 01-25-07	01-25-07				JJH / 01-25-07								
6-18	0.30												
18-50	0.50												
50-120	0.70												
120-250	0.90												
250-500	1.20												